

WIDE VIEW®

OPERATIONS MANUAL



fish wide open!

INSTALLATION PREPARATION

PARTS SUPPLIED

PARTS SUPPLIED

Before installing your new Humminbird fishfinder, please ensure the following parts are included in the box:

- Fishfinder
- Transducer with 20' (6m) of cable and mounting hardware kit
- Mounting system and mounting hardware kit
- 6' (2m) power cable
- Publications kit

If any of these items is missing, call our Customer Support Hotline.

ACCESSORIES

Humminbird offers a wide assortment of accessories that complement and expand the capability of your new fishfinder. These accessories are designed with the same high standards and are backed by the same one-year warranty. The Humminbird Accessory catalog included with your unit contains descriptions of the many accessories available and ordering information. All Humminbird accessories are available through your full-service Humminbird dealer or factory direct through our number listed in the Customer Support section.

INSTALLATION OVERVIEW

Your Humminbird fishfinder consists of two primary components to install: the control head and the transducer.

The control head contains the sonar transmit and receive circuitry, as well as the user controls and display. It should be installed in a location that provides access to the controls and visibility while in use. The control head mounts on a quick disconnect mounting system that swivels and tilts providing flexibility for viewing from almost anywhere on the boat.

The transducer converts electrical energy from the transmitter into mechanical pulses or sound waves. The transducer also receives the reflected sound waves and converts them back into electrical signals for display on the control head. It should be installed in contact with the surface of the water in an area that has smooth waterflow- usually on the transom of the boat. There are several mounting options for the transducer. Review the following section to determine the method that works for you and your boat.

INSTALLATION PREPARATION

INSTALLATION OVERVIEW

Determining How to Mount the Transducer

Your Humminbird fishfinder includes a standard transducer. This transducer can be mounted on the transom of the boat or bonded to the inside of a fiberglass hull boat.

The transom installation, which is the most widely used, places the transducer on the outside of the boat hull. This technique produces the least signal loss, and provides a way to adjust the transducer after installation. The mounting hardware included is designed to protect both the boat and the transducer should the boat strike debris in the water or when trailering.

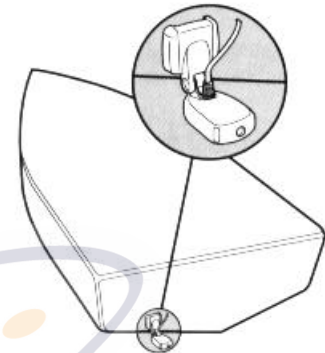

Transom Mounted Transducer

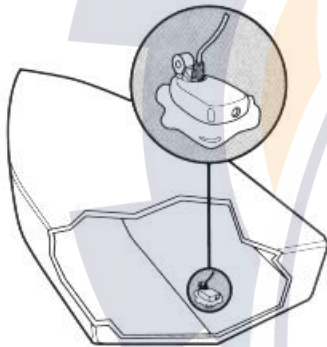

Inside the Hull Mounted Transducer

As an alternative to transom mounting, it is possible on many fiberglass-hulled boats to glue the transducer on the inside of the boat hull. Since fiberglass has similar sonar characteristics as water, the sonar signal can pass through the boat hull with minimal loss. The hull of the boat must be single layer construction (not double-hulled) Also, any air trapped in the lamination of the fiberglass would prevent the sonar signal from passing through.

Inside the hull installations require no holes be drilled into the boat and through experimentation, high-speed operation comparable to transom mounting can be achieved. Two-part slow cure epoxy (not included) is required to glue the transducer in place.

INSTALLATION PREPARATION

ALTERNATE MOUNTING METHODS

ALTERNATE TRANSDUCERS AND MOUNTING METHODS

Your Humminbird fishfinder comes with everything necessary for installation and operation on most boats. However, there are several situations which may require a different type of transducer. Inboard boats, wood or metal hulls, and sail boats create unique transducer mounting needs. Alternate transducers and mounting methods are detailed below.

Portable Mounting

The standard transducer can be adapted for portable installations with a portable mounting kit available from Humminbird. This accessory adapts your transducer to a suction cup mount for temporary installation on the boat hull or other surface.



Trolling Motor Mounting

The standard transducer can also be adapted to mount on most trolling motors using a different accessory kit. This accessory includes a bracket and hose clamp that allows mounting the transducer to the body of most trolling motors.



Thru-Hull Mounting

Thru-hull transducers install through a hole drilled in the hull of the boat. Larger boats or boats with inboard motors create turbulence that make transom mounting ineffective. Also, hulls that are very thick or are double layered, or made from materials such as wood or metal, (which do not conduct sonar signals) make inside the hull mounting inadvisable.

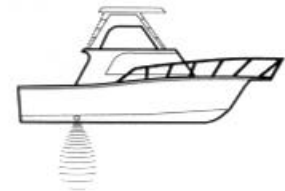

Thru-hull mounting may require the use of a fairing block to level the transducer with the waterline. Also, since special tools and knowledge may be required to perform this type of installation, it is best to refer to a qualified marine technician.

INSTALLATION PREPARATION

TRANSDUCER EXCHANGE

TRANSDUCER EXCHANGE

Other transducers are available as replacements for the standard transducer. You may exchange your new and unassembled transducer for another type by returning it to the address listed in Customer Support. Some transducers may have additional cost. Refer to the Accessory catalog or call Customer Support for information.

BEGINNING INSTALLATION

Now that you have determined the transducer mounting method you can begin installation of your new Humminbird fishfinder. The installation guide included on the next few pages provides detailed step by step instructions for installation of the control head and transducer. For transom mount transducer installations you will need the mounting template included with your manual.

In addition to the parts included you need the following for installation and operation:

- A powered hand drill and various drill bits
- Philips and flat-head screwdrivers
- A ruler or measuring tape
- Pen or pencil
- 12 volt power source (your boat's battery)
- A 1-amp fuse
- A fuse holder (if you are wiring directly to the boat's battery)
- Silicone sealant (for sealing drilled holes)
- 2-part, slow-cure epoxy (for inside the hull transducer installations)

INSTALLATION

TRANSOM INSTALLATION

Do not begin this transducer installation until you read the Installation Preparation in the Operation Guide. This chapter contains information critical to the correct installation of your transducer.

Due to the wide variety of boat hulls, only general instructions are presented in the installation guide. Each boat hull represents a unique set of requirements that should be evaluated prior to installation.

TRANSOM INSTALLATION

Step One - Determine Where to Mount the Transducer

Begin the transducer installation by determining where on the transom to install the transducer. Consider the following to find the best location:

- It is very important to locate the transducer in an area which is relatively free of turbulent water. As a boat moves through the water, turbulence is generated by the weight of the boat, and the thrust of the propeller(s). This turbulent water is normally confined to areas immediately aft of ribs, strakes or rows of rivets on the bottom of the boat, and in the immediate area of the propeller(s) (Figure 1). On outboard or inboard/outboard boats it is best to stay at least 15" (40cm) to the side of the propeller(s).
- If possible, viewing the transom of the boat while the boat is moving will provide the best means of locating turbulence free water. If maximum high-speed operation is a high priority, this is the recommended method. If this is not possible, select a location on the transom where the hull forward of this location is smooth, flat, and free of protrusions or ribs.
- The transducer when mounted should point straight down. The design of the transducer will accommodate a wide range of deadrises and remain ported straight down (Figure 2).
- On boats with stepped hulls, it may be possible to mount the transducer on the step. Never mount the transducer on the transom behind a step, as this area of the transom will not be in contact with the water at high speed (Figure 3).

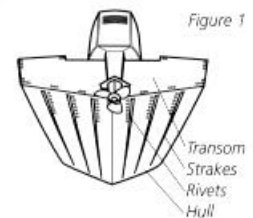

Transom Mounting Location

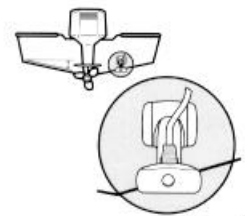

Figure 2

Stepped Hull



Figure 3

INSTALLATION

TRANSOM INSTALLATION

- If the propeller(s) is (are) forward of the transom, it may be impossible to find an area clear from turbulence, and a different mounting technique or transducer type should be considered.

Step Two - Drill the Mounting Holes

1. Remove the mounting template from the front of the Operations Manual.
2. Hold the template on the transom of the boat in the location where the transducer will be installed (Figure 4). Align the template vertically, ensuring the lower edge of the transom meets with the bottom corner of the template.
3. Using a pencil or punch, mark the two mounting holes shown on the template onto the transom. Do not mark or drill any other holes at this time.
4. Using a 5/32" (4mm) bit drill the two holes to a depth of approximately 1" (3cm). On fiberglass hulls, it is best to start with a smaller bit and use progressively larger drill bits to reduce the chance of chipping or flaking the outer coating.

Template alignment

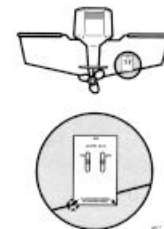

Figure 4

Transducer Assembly

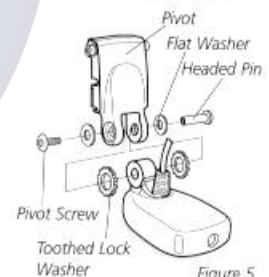

Figure 5

Step Three - Assemble the Transducer

1. Attach the Pivot to the transducer body as shown in Figure 5, using the #8 – 3/8" (9mm) long allen headed pivot screw, the headed pin, the two flat washers, and the two toothed lock washers.

Note: The toothed lock washers must be positioned between the transducer and the pivot ears. The flat washers must be positioned to the outside at the pivot ears.

2. Using the Allen wrenches provided, loosely tighten the pivot screw (Figure 6). Do not completely tighten the assembly at this time, so the pivot angle can be adjusted later.
3. Insert the pivot/transducer assembly into the mounting bracket as shown in Figure 7. Do not snap the assembly closed.



Figure 6

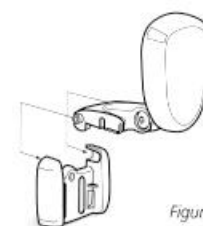

Figure 7



INSTALLATION

TRANSOM INSTALLATION

Step Four - Mount the Transducer to the Transom

1. Apply silicone sealant to the mounting holes drilled into the transom.
2. Align the transducer assembly with the drilled holes in the transom (Figure 8).
3. Use either a flat head screwdriver, a 5/16" (8mm) hex driver, or a 5/16" (8mm) socket to mount the assembly. Using the two #10 – 1" (25mm) long slotted hex head screws, mount the transducer assembly to the transom as shown. Do not fully tighten the mounting screws in order to vertically adjust the transducer. Snap the pivot down into place.

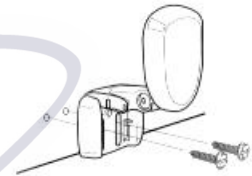

Figure 8

Step Five - Adjust the Running Position of the Transducer

The bracket allows height and tilt adjustment, the pivot screws allow angular adjustment. Initially, adjust the transducer as described in the following paragraphs. Further adjustment may be necessary to refine the installation after high speed testing.

1. First adjust the pivot angle of the transducer body so its length is parallel with the length of hull of the boat. Then pivot the transducer down so the rear is about 1/4 inch (6mm) lower than the front (Figure 9).
2. Fully tighten the two pivot screws using the Allen wrenches. It may be necessary to retighten the pivot screws after the initial use as the plastics may still be seating to the lock washers.
3. Adjust the height of the assembly so the face of the transducer is 3/16" (4.5mm) beneath the lower edge of the transom (Figure 10). Mark the position of the mounting bracket on the transom with a pencil.
4. Force the pivot to the up position to gain access to the mounting screws. Assure the transducer location has not changed, then fully tighten the two mounting screws (Figure 11). Snap the pivot back down.

Running Position Adjustment



Figure 9

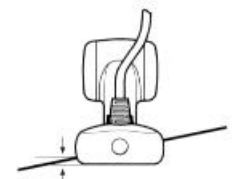

3/16" (4.5mm)

Figure 10

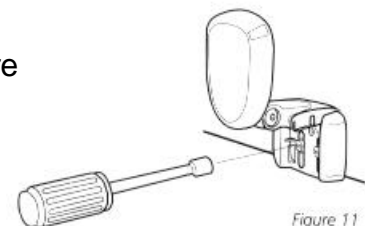

Figure 11

Confirm the pivot angle has not changed.

Note: A third screw location is provided for the

mounting bracket. Drill this hole and install the screw after final testing and adjustments have been completed.



INSTALLATION

TRANSOM INSTALLATION

Step Six - Route the Cable

There are several ways to route the transducer cable to the area where the control head will be installed. The most common procedure routes the cable through the transom into the boat.

Inside the boat there is often a channel or conduit used for other wiring that the cable can be routed along. Do not cut or shorten the transducer cable and try not to damage the cable insulation. Route the cable as far as practical from the VHF radio antenna cables or tachometer cable to reduce the possibility of interference.

If the cable is too short, extension cables are available to extend the transducer cable up to a total of 50' (15 m). Call Humminbird Customer Support for more information.

Follow these steps to route the cable through the transom:

1. Drill a 5/8" (16mm) hole above the water line. Route the cable through the hole.
2. Fill the hole with silicone sealant.
3. Place the escutcheon plate over the hole and attach with the two #8 x 5/8" (16mm) screws.
4. Secure the cable by attaching the cable clamp to the transom using a #8 x 5/8" (16mm) screw.

Note: The transducer will pivot up to 90 degrees in the bracket. Allow enough slack in the cable for this movement. It is best to route the cable to the side of the transducer so the cable will not be damaged by the transducer during movement.

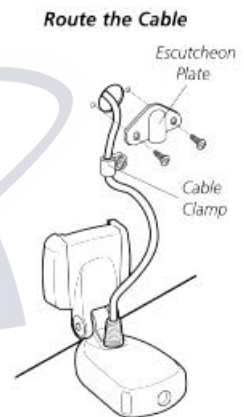

Figure 12

INSTALLATION

INSIDE THE HULL INSTALLATION

INSIDE THE HULL INSTALLATION

Inside the hull installation requires the mount system and control head be installed and operational. See Installing the Control Head for instruction on installing the unit.

Inside the hull mounting generally produces good results in single thickness fiberglass-hulled boats. Humminbird cannot guarantee depth performance when transmitting and receiving through the hull of the boat since some signal loss occurs. The amount of loss depends on hull construction and thickness, and the installation.

This installation requires slow-cure two-part epoxy. Do not use silicone or any other soft adhesive to install the transducer, as this material reduces the sensitivity of the unit. Five minute epoxy has a tendency to cure before all the air bubbles can be purged.

Step One - Determine the Mounting Location

Begin the transducer installation by determining where inside the hull to install the transducer. Consider the following to find the best location:

- Observe the outside of the boat hull to find the areas that are mostly free from turbulent water. Avoid ribs, strakes, and other protrusions as these create turbulence (Figure 14).
- As a general rule, the faster the boat can travel the further aft and closer to the centerline of the hull the transducer has to be located to remain in contact with the water at high speeds.

Step Two - Test the Mounting Location

There is no opportunity for adjustment after the transducer glued in place. Therefore, it is best to perform a trial installation on inside the hull transducers first, and run the boat at high speeds to determine the best mounting area.

1. At the identified mounting location, lay the transducer body face down with the pointed end towards the bow.
2. Fill the hull with enough water to submerge the transducer body. Use a sand filled bag or other heavy object to hold the transducer in position.

Transducer Mounted Inside the Hull

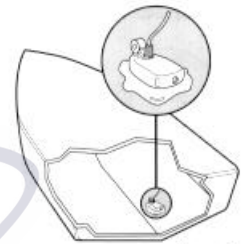

Figure 13

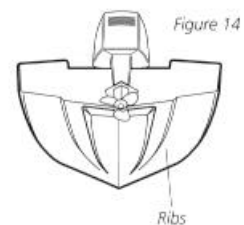

Figure 14

Preferred Mounting Area



Figure 15

The transducer cannot transmit through air. The water purges any air from between the transducer and the hull and fills any voids in the coarse fiberglass surface.



INSTALLATION

INSIDE THE HULL INSTALLATION

3. Power up the Control Head.
4. Run the boat at various speeds and water depths while observing the screen on the Control Head. If the unit functions well at low speeds but begins to skip or miss the bottom at higher speeds, the transducer needs to be moved. If depth performance is required, test the fishfinder in water at the desired depth. Test different locations in the hull until the optimum performance is achieved.

Step Three - Permanently Mount the Transducer

1. Once the mounting location is determined, mark the position of the transducer.
2. Remove the water from inside the hull and thoroughly dry the mounting surface. If the surface is excessively rough, it may be necessary to sand the area to provide a smooth mounting surface.

Ensure the mounting area is clear and dry.

3. Mix an ample quantity of two-part slow-cure epoxy slowly and thoroughly. Avoid trapping air bubbles.
4. Coat the face of the transducer and the inside of the hull (Figure 16).
5. Press the transducer into place with a slight twisting motion to purge any trapped air from underneath, keeping the pointed end of the transducer body pointed forward (Figure 17).

Note: Proper operation requires the pointed end of the transducer body to face towards the bow.

6. Weight the transducer so it does not move while the epoxy is curing.

When the epoxy cures, no water is necessary inside the hull. Neither water, spilled gasoline, or oil will affect the performance of the transducer.

Figure 16

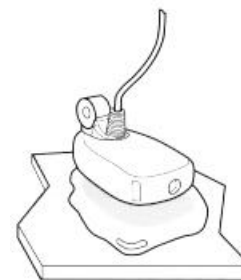

Figure 17

INSTALLATION

CONTROL HEAD INSTALLATION

CONTROL HEAD INSTALLATION

Step One - Determine Where to Mount

Begin the installation by determining where to mount the control head. Consider the following to determine best location:

- The cables for power, transducer and temp/speed accessories (if applicable) should be installed first and must reach the mounting location. Extension cables are available.
- There are two ways to route the cables to the unit: through a hole in the mounting surface underneath the mounting bracket or from a hole outside the mounting bracket. Routing the cables down under the mount provides maximum weather protection; however this is not always feasible if the area under the fishfinder is inaccessible. In this case, route the cables through a hole at another location and cover with the supplied hole cover.
- The mounting surface should be adequately supported to protect the fishfinder from excessive wave shock and vibration, and provide visibility while in operation.
- The mounting area should allow sufficient room for the unit to pivot and swivel freely, and for easy removal and installation (Figures 18-19).

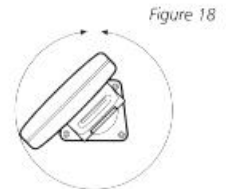

Figure 18

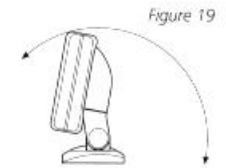

Figure 19

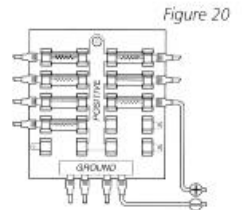

Figure 20

Step Two - Connect the Power Cable to the Boat

A 6' (2m) long power cable is included to supply power to the fishfinder. You may shorten or lengthen the cable using 18 gauge multi-stranded copper wire.

CAUTION: Some boats have 24 or 36 volt electric systems. Be sure your unit is connected to a 12 VDC power supply.

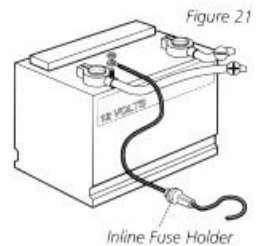

Figure 21

Inline Fuse Holder

The Power can be connected to the boat's electrical system at two places: a fuse panel, usually located near the console, or directly to the battery.

If a fuse terminal is available, use crimp-on type electrical connectors (not included) that match the terminal on the fuse panel. Attach the black wire to ground, and the red wire to 12 VDC power (Figure 20). Be sure to use a one amp

fuse in the connection. If you must wire the control head directly to a battery, be sure to install an inline fuse holder



INSTALLATION

CONTROL HEAD INSTALLATION

and one amp fuse (not included) for the protection of the unit (Figure 21). Humminbird is not responsible for over voltage or over current failures.

In order to minimize the potential for interference with other marine electronics a separate power source (such as a second battery) may be necessary.

Step Three - Drill the Mounting Holes

1. Set the mounting bracket in place on the mounting surface. Mark the four mounting screw locations with a pencil or punch.
2. Set the mounting bracket aside, and drill the four mounting screw holes using a 9/64" (3.6mm) bit.

Step Four - Run the Cables

1. If the cables must pass through a hole underneath the mounting surface, mark and drill a 1" (25mm) hole centered between the four mounting holes (Figure 22).

Note: if the cables must pass through the mounting surface at a different location, drill the 1" (25mm) hole at that location and pass the cables through from underneath. Also, you must break out the tabs on the rear of the mounting base using needle nose pliers (Figures 24-25).

2. Insert all cables through the 1" (25mm) hole from beneath the mounting surface.
3. Pass the cables through the grommet (if the cable hole is underneath the mounting bracket) then press the grommet in place around the cables and into the 1" (25mm) hole.
4. Pass the cables through the mounting base, out the top of the mounting bracket.
5. Place the mounting bracket on the mounting surface aligned with the drilled holes. Insert the four flathead wood screws into the mounting holes and tighten fully (Figure 23).

Figure 22

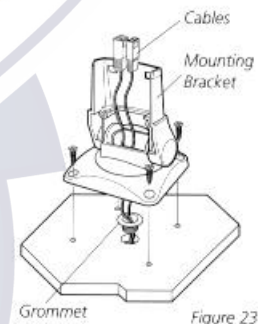

Figure 23

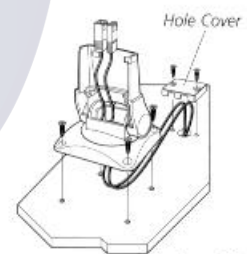

Figure 24



Figure 25

Optional: If the cables pass outside the mounting bracket, install the hole cover over the hole and fasten in place using the two #8 x 7/8" (22mm) wood screws (Figure 24).



INSTALLATION

CONTROL HEAD INSTALLATION

Step Five - Assembling the Connector Holder

1. Insert the cable connectors into the connector holder. The cable connectors are labeled, and there are corresponding labels on the connector holder (Figure 26). The slots for the connectors are keyed to prevent reverse installation, so do not force the connector into the holder.
2. Carefully pull the excess cable from beneath the mounting surface so the connector holder aligns with the mounting holes on the front of the mounting bracket (Figure 27).
3. Snap the support plate to the rear of the connector holder (Figure 28).
4. Insert the connector holder into place and use the two #6-32 x $\frac{3}{4}$ " (9mm) screws to fasten it to the mounting bracket (Figure 28).
5. Install the control head by sliding it onto the mounting bracket until it is fully seated. To remove the unit simply depress the latch on the rear of the unit and lift (Figure 29).

Your Humminbird is now ready for operation.

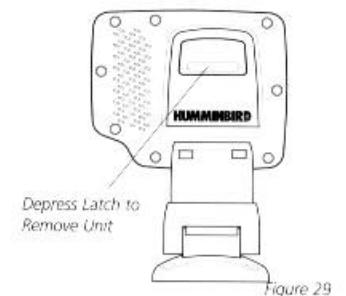
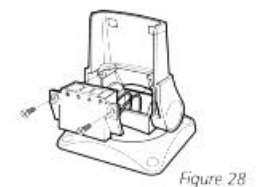
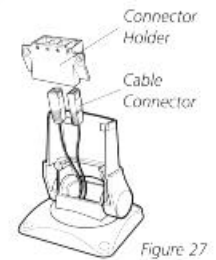
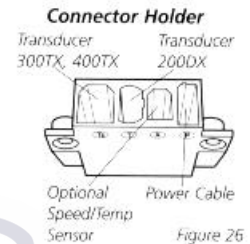

INSTALLATION

TEST THE INSTALLATION

TEST THE INSTALLATION

Testing should be performed with the boat in the water, however you can initially confirm basic operation with the boat trailered.

Press POWER once to turn the unit on. There will be an audible chirp when any button is pressed to confirm the button press. If the unit does not power-up, ensure the unit is fully seated on the mount and that power is available.

The first screen provides four options: Start-up, Options, Simulator, and Diagnostic. A message at the bottom of the screen indicates the transducer connection. If no transducer is detected (or one is not connected), the message will indicate this and the unit will go into simulator after the initial screen times out.

Note: the transducer must be submerged in water for reliable transducer detection.

If a transducer is detected, the unit will enter "Start Up" or normal operation unless you choose another option. If you do not press any button before the timer reaches "0", the normal operation screen is displayed. If the boat is in water, sonar data appears.

If the bottom is visible on screen with a digital depth readout, the unit is working properly. Ensure the boat is in water greater than 2' but less than the depth capability of the unit and the transducer is fully submerged. Remember the sonar signal cannot pass through air.

If the unit is working properly gradually increase the boat speed to test high-speed performance. If the unit-functions well at low speeds but begins to skip or miss the bottom at higher speeds, the transducer requires adjustment. Refer to the appropriate transducer installation section for more detail.

Note: it is often necessary to make several incremental transducer adjustments before optimum high-speed performance is achieved.

Important: For Transom Mount transducer installations, install the third mounting screw after the final transducer adjustments.



TESTING THE INSTALLATION

After installing your Wide View unit and transducer, you are ready to test the installation. Testing should be performed on the water, since that is the best way to confirm your transducer's performance.

With your boat in the water, press POWER once to turn the unit on. If you press and hold the POWER button, the simulator will be enabled. To power the unit for normal operation, press and release the POWER button. Notice that when any button is pressed there is an audible "chirp" that confirms the button press.

Momentarily, information will begin to "march" across the screen from right to left. Remember that as each column advances on the screen, it contains information gathered from several transmit and receive cycles. The column of information on the far right side of the screen is the most current information, or the view directly under your boat. If your boat is moving, an accurate depiction of the terrain you have just covered is created on-screen.

Increase your boat speed to ensure that the transducer remains in contact with turbulence-free water at higher boat speeds. All Humminbird depthsounders are designed to work at speeds of 70 MPH or more, however, use caution when operating any boat at high speed. (High-speed testing does not apply to portable or trolling motor mounted transducers)

If the Wide View fails to locate the bottom and advance information across the screen as shown, ensure first that the depth of the water is not in excess of the unit's capability. Also, ensure that the unit is fully seated on the mount, and the cable connections are correct. (The label on the cable connector matches the label on the connector holder).

If no audible "chirp" is heard when pressing the POWER button, the power cable or the fuse terminal may be the problem. If the unit obviously powers up, but no bottom information is seen on the display, the transducer is most likely the problem.

If the Wide View unit operates well at idle or slow speeds, but loses the bottom or displays erroneous readings at higher speeds, the transducer is losing intimate contact with the water at high speed. If your transducer is transom mounted, adjusting the running angle and depth of the transducer may solve the problem. Several test runs and transducer adjustments may be necessary to optimize transducer performance.



USING THE WIDE VIEW

The Wide View is simple to use. Simply press the POWER button, and the unit will automatically locate the bottom, adjust the depth range and sensitivity to an appropriate level, and draw a picture of the terrain beneath your boat. If POWER is the only button you press, you will benefit from the advanced automatic bottom tracking capability of the unit. However, if you choose to experiment with the many features and controls the Wide View offers, you can customize the presentation of information to suit your particular needs. The Wide View offers a wide variety of settings and types of display, to satisfy any sonar need.

SIMULATOR OPERATION

The Wide View contains a simulator which allows you to use the unit as if you were on the water. This simulator is invaluable for learning how to operate the many features of the Wide View unit.

With the unit turned off, press and hold POWER until you hear a continuous chirp. This initiates the simulator operation and "simulator" will be displayed at the top of the screen. Your Wide View will simulate all functions as if it were actually on the water.

To exit the simulator, press POWER to turn the unit off. Pressing POWER again will power-up the unit for normal operation.

When in simulator operation, the Wide View unit will respond to control inputs as if it were in actual operation, so feel free to experiment with the many features

and functions to customize the Wide View unit for your particular application.

The Wide View remembers many user settings made while in actual operation, even if power is disconnected. If setting adjustments are made while using the simulator they will not be retained and the unit will default to the latest adjustments made during actual operation.

WHAT YOU SEE ON-SCREEN

The first thing you may notice about the Wide View unit is the high-resolution, wide screen LCD display. The LCD display uses super-twist technology, for maximum viewability and is ruggedized for tough shock and vibration endurance. The display is also backlit for nighttime operation, and uses special components so it can operate at temperatures more extreme than you are likely to encounter.

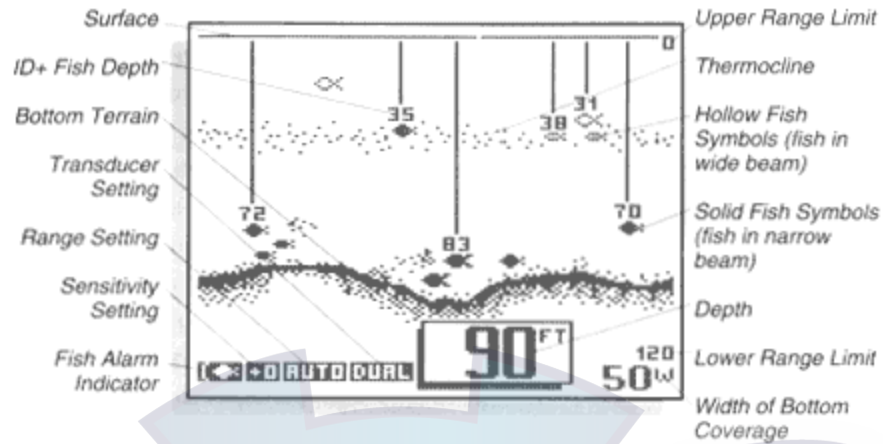

The Wide View allows you a number of ways to display sonar information. Some features are used in conjunction with special accessories such as the Boat Speed and Water Temperature gauge, or "Wide Side" side looking transducer.

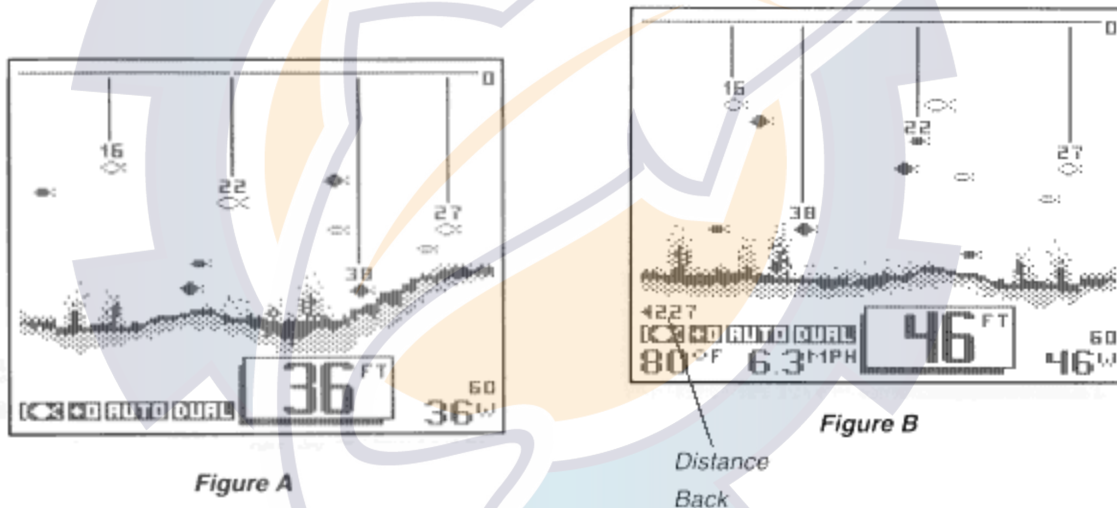

Figure A shows the default screen layout. If you are using the temperature/speed accessory, the screen layout will be slightly different, as shown in Figure B. With the optional speed and temperature gauge connected a distance back number is displayed which represents the linear distance of the sonar information being displayed. The faster your boat is traveling, the greater the distance number.

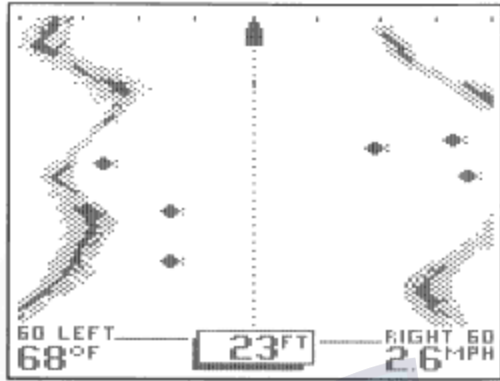

Figure C

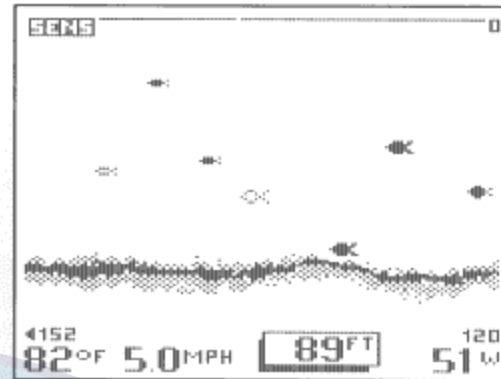

Figure D

If you are using the Wide Side accessory transducer, the screen layout will look like Figure C.

Later, you will learn of another feature called "advanced operation". This feature uses yet another screen layout as shown in Figure D which maximizes the display for the terrain and target presentation.

The number of vertical pixels (picture elements or dots) in a given depth range determines the display resolution, or ability to differentiate targets close to the bottom or other targets. The Wide View is capable of distinguishing between targets only 6 inches apart, and show fish within 6 inches of the bottom.

On all screens but the Wide Side view, the horizontal line at the top of the display is the "Zero" line. This represents the surface of the water. The "Zero" line will always have a gap which moves as the screen updates. This gap lets you know that the display is updating even if the bottom terrain remains the same or is not visible on the selected depth range. The farthest right column of information is the most recent information, and it shows what is directly under your boat.

At power-up, the Wide View locates the bottom and adjusts the depth range to a setting most appropriate for that depth. The bottom will be usually shown about 2/3 of the way down the display. The Structure ID depiction of the bottom may appear differently in different situations. If the bottom is very hard and smooth, the bottom depiction will be narrow and dense. If the bottom is mud or soft sand, the bottom depiction will be thick and less dense. This indicates that much of the sonar signal is absorbed by the soft bottom. If the bottom is rugged and varying, such as a rocky bottom, the depiction will be textured and vary in density. Structure, such as submerged trees or brush, or other objects are clearly displayed above the solid bottom return, in varying densities of pixelization. This bottom depiction is useful in locating structure, by comparing relative density as well as depth.



Hard, Smooth Bottom



Soft Mud Bottom

The transmitted sonar signal travels downward, and is reflected back toward the surface by the bottom or other objects for display on screen.

The signal does not stop there - it is reflected downward again by the surface of the water, and a weak "second return" is usually visible if the depth range is sufficient to see it. A second return is shown in the figure at the bottom right. Some users use this second return as an indicator when setting the sensitivity bias.

If a target is detected between the surface and the bottom, it is displayed as a fish symbol. Depending on the strength of the signal reflected from the object, one of three different size symbols is used. These reflected signals are "normalized" for depth, so that a small fish does not appear to be a large fish if it is close to the boat.

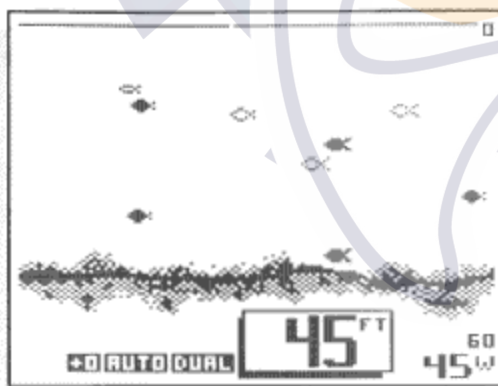

Rocky Bottom

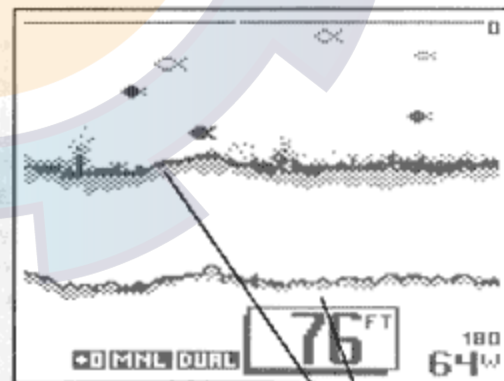

Second Return
Bottom Terrain
(Primary Return)

Since some species of fish tend to be better reflectors of sonar than others, the strength of return is not always an accurate indicator of fish size, however, typically, the larger the fish, the larger the signal return.

Additionally, since the Wide View uses a dual beam transducer, each of the two beams is evaluated independently, and some directional indication is possible. If a target is seen in the

narrow beam, it is located directly under your boat, and is displayed as a solid fish symbol. If a target is seen in the wide beam only, it can be assumed that the target is at the outside of the sonar coverage area, not directly under the boat, and is displayed as a hollow fish symbol.

CONTROL FUNCTIONS

The Wide View unit uses only seven buttons to control all functions. The controls are divided into two groups: POWER, STOP, and LIGHT are one group, and the Menu System controls are the other group. When any button is pressed, an audible "chirp" will verify the control input.



POWER, as previously discussed, powers the Wide View for normal operation. Also, if the unit is powered off, press and hold POWER until you hear a continuous "chirp" to enable simulator operation as discussed in "Simulator Operation." Pressing POWER when the unit is in normal or simulator operation will power the unit off.

STOP freezes the display to allow closer study. Pressing STOP again will resume normal operation. Also, if a menu is on-screen, STOP will retain the menu onscreen until STOP is pressed again. The digital bottom depth will continue to update, as usual, even if the display is stopped.

LIGHT enables a two-level display backlight and backlit keypad. Pressing once will turn the light on low, pressing a second time will increase the backlight to the high setting, and pressing a third time will turn the backlight off.



The four remaining buttons work together to control the Menu System - an array of menu controlled functions.

MENU brings a menu on-screen for adjustment, or if a menu is already present, the next menu in sequence will appear. Menus will go off-screen and normal operation will resume after a short period of time. If you wish to keep the menu on-screen for an extended period of time, press STOP.

UP arrow selects the next larger or next sequential adjustment within the menu. Holding an Arrow button down will cause the unit to continue to make the adjustment, until a limit is reached, and the limit alarm sounds.

DOWN arrow selects the next smaller adjustment within the menu.

ENTER is used to toggle other menu options on and off.

All menus use the same general layout as shown in the sample menu at the right. The heading of the menu is at the top. The area in the center is controlled by the UP and DOWN arrows, and the area under the horizontal line is controlled by the ENTER button. Not all menus are affected by all controls, but the layout is the same regardless. Pressing MENU repeatedly will sequentially display all available menus.

MENU FUNCTIONS

The following section explains each menu in detail, and how these adjustments can be used to extract the maximum information from the sonar returns. With several exceptions, once a setting has been changed, the Wide View will remember that setting until it is again changed, even if power is disconnected.

Transducer

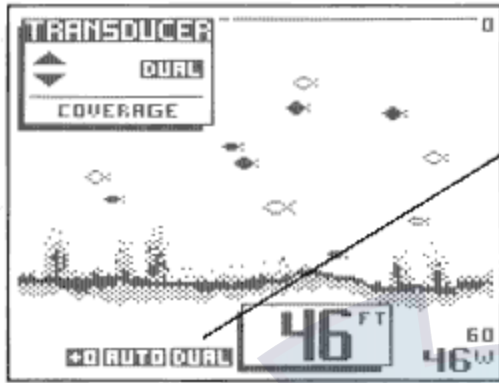

"Dual" Setting

The Wide View uses a special "dual element" transducer that transmits a wide and narrow beam simultaneously. Using two different beams allows the unit to compare the returns from each beam individually, and gain more information about the terrain below.

For instance, if a fish is detected in the wide beam only, the target may be some distance

from your boat, however, if a target is detected in the narrow beam, the fish is directly under your boat. This directional information about the target is shown on-screen as hollow fish symbols for wide beam returns, and solid fish symbols for narrow beam returns.

The options in the Transducer menu are "Dual", which uses both transducer elements for transmitting and receiving the sonar signals, "Narrow" which selects the 16 degree narrow beam element only, and "Wide" which uses only the 53 degree element. Different onwater situations and personal preference may dictate the use of only one element, however the Wide View is designed to gather maximum information when both narrow and wide elements are used simultaneously (Dual). Pressing ENTER will display additional information about the selected beam's width of bottom coverage. The width of bottom coverage number is displayed onscreen and is continually updated depending on the water's depth.



"Narrow" Setting

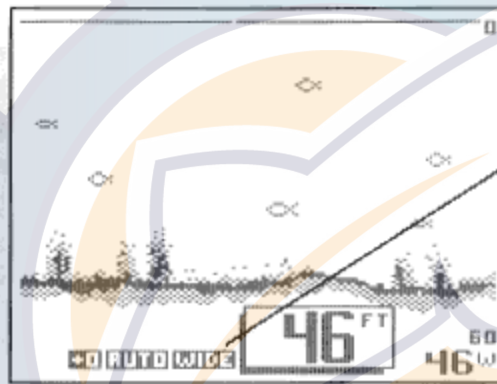

"Wide" Setting

If you are using the optional Wide Side transducer, and have selected side-looking operation, the adjustments available in the Transducer menu will be "Left", "Right", and "Both". More information about these options is discussed in "Wide Side Operation".

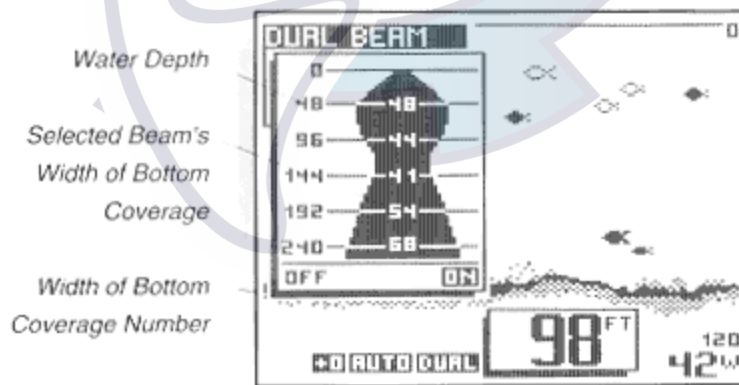

Sensitivity



Sensitivity Setting

As the Wide View receives returned signals, the sensitivity of the receiver is adjusted automatically based on a number of factors such as the depth of the water, and the signal clarity. In murky water, full of debris, the Wide View will select a lower sensitivity setting. In clear water, where there is little debris to deflect the sonar signal, the sensitivity is set higher.

The Sensitivity menu allows you to "bias" this automatic setting up or down based on personal preference.

You can select a bias of +5 to -5, for 11 different bias settings. A bias setting of "0" has no effect on the automatic function. A +3 setting selects a sensitivity setting three steps higher than the unit would normally select, so even the smallest returns are displayed onscreen.

A setting of -2 sets the sensitivity two steps below what the unit would normally select, so only the largest targets or other returns are displayed.

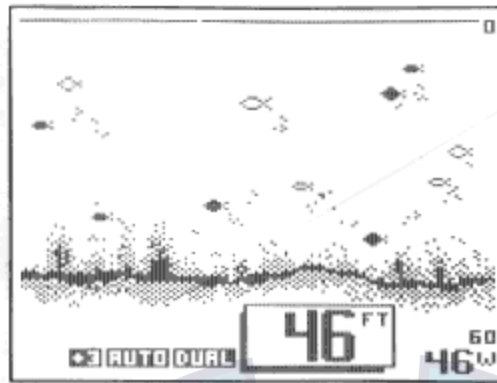

Sensitivity Bias of +3

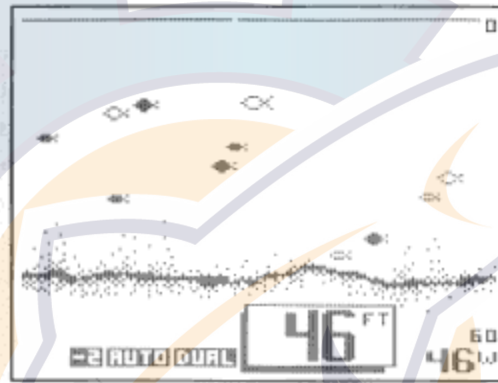

Sensitivity Bias of -2

Another use of the Sensitivity menu is to select the bottom representation. The Wide View normally displays a variable Structure ID bottom, which can allow experienced users to determine the texture or relative hardness of the bottom. For simplicity, you can select a black bottom using the ENTER button. This blackens in the display below the bottom for easiest recognition of the bottom location, even from a great distance.

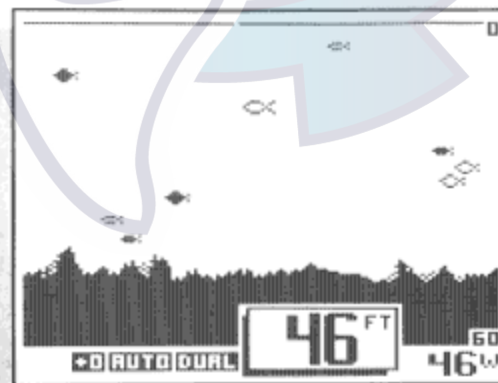

Blackened Bottom

Range

The Wide View adjusts the depth range automatically, so the bottom return is displayed at the bottom 1/3 of the display. This leaves the top 2/3 to display anything between the surface and the bottom. As your boat moves over deeper or shallower water, the unit adjusts the depth range of the display to keep the bottom return in the same general area on the screen.

However, you may choose to control this range adjustment manually. By pressing ENTER, you can select manual operation, meaning the unit will no longer adjust the depth range automatically. The depth range selected is controlled by the UP and DOWN arrow buttons. Ranges of 0-15', 30', 60', 120', 180', 240', 360', 480' & 600' can be selected. An onscreen icon indicates whether the unit is in "AUTO" (automatic) or "MNL" (manual) range control.

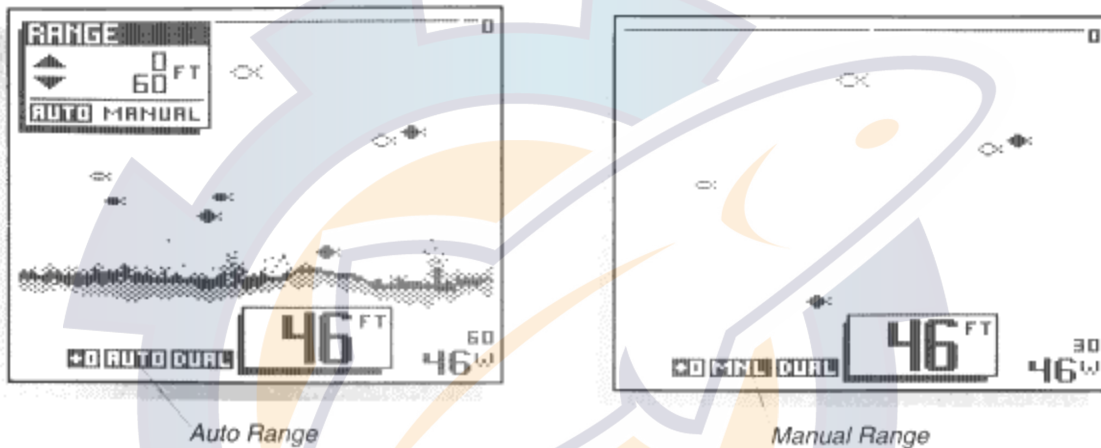

If you alter the depth range, Manual operation is automatically selected. This feature is valuable if you are only interested in targets near the surface. The Wide View will always display the digital depth of the water, regardless of whether the bottom is shown on the selected depth range.

Zoom

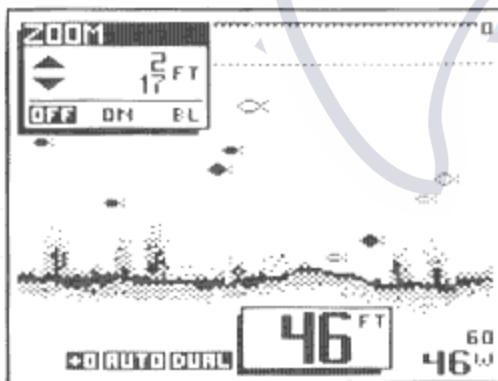

Another form of range control is Zoom. Zoom allows selection of various ranges for full screen viewing, while maintaining a view of the full range. By using the display to view a smaller area, the effective display resolution is increased, and the units ability to separate targets close together is enhanced.

The zoom range is determined by the depth range in use when Zoom is enabled. In shallow water, when the 15' or 30' depth range is used, the zoom range will be 7-1/2'. If the 60' or 120' depth range is in use, the zoom range will be 15', if a 180' - 480' depth range is used, the zoom range will be 30', and if the 600' range is in use, the zoom range will be 60'.

To enable Zoom, adjust the horizontal lines to the depth of the zoom range using the UP and DOWN arrow buttons, then enable Zoom using the ENTER button.

Once you are in zoom, refer to the preview area and adjust the depth of the zoom range by using the UP and DOWN arrow buttons. The Zoom menu will not appear when an adjustment is made unless MENU is pressed.

The digital depth readout will continue to track the bottom even when Zoom is enabled.

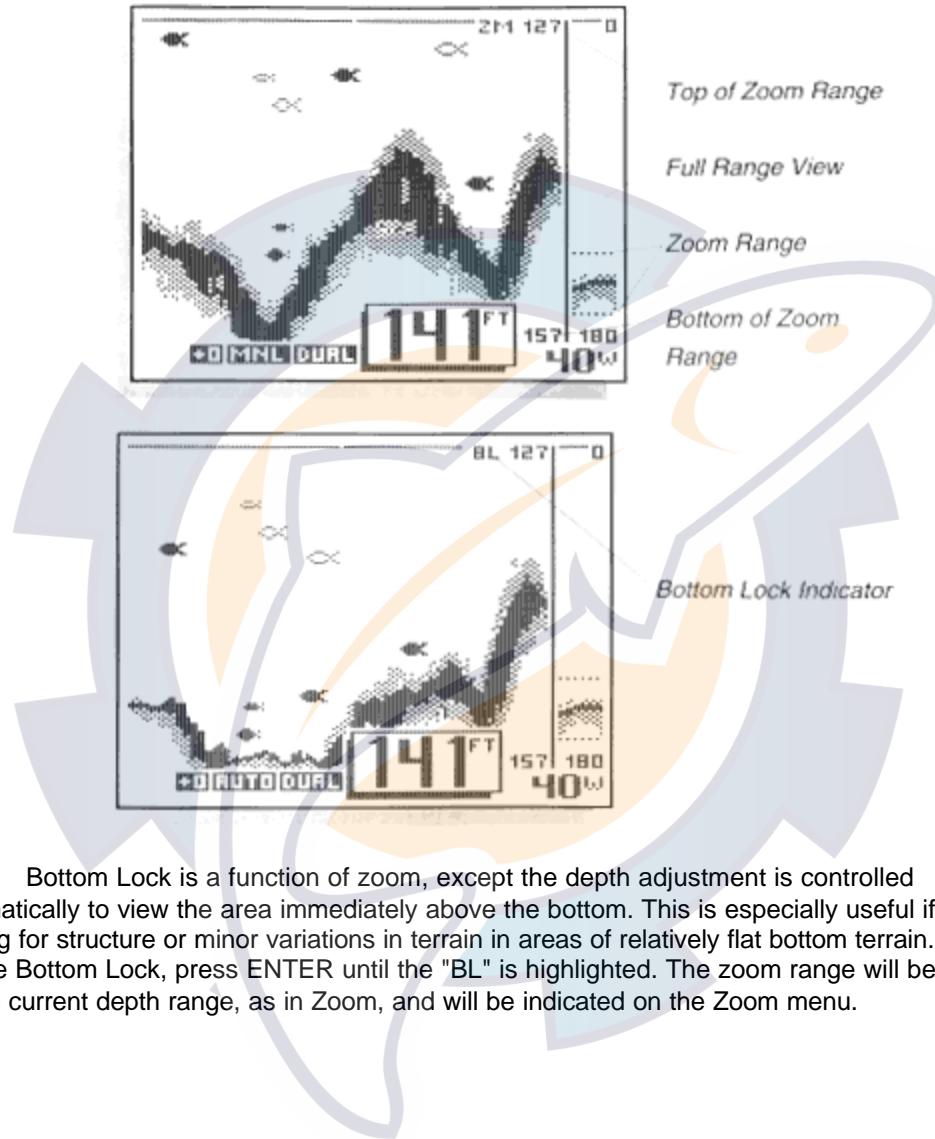

Bottom Lock is a function of zoom, except the depth adjustment is controlled automatically to view the area immediately above the bottom. This is especially useful if you are looking for structure or minor variations in terrain in areas of relatively flat bottom terrain. To enable Bottom Lock, press ENTER until the "BL" is highlighted. The zoom range will be controlled by the current depth range, as in Zoom, and will be indicated on the Zoom menu.

Bottom Alarm



The Wide View contains an audible alarm to warn you of shallow water depths. This alarm is adjustable from 2' to 99' of depth. To enable the alarm, simply adjust the alarm depth using the UP and DOWN arrow buttons, and press ENTER. Whenever the depth of the water beneath your boat is equal to or less than the selected alarm depth, a continuous alarm will sound.

To disable the alarm, either move to deeper water, or select the Bottom Alarm menu, and press ENTER to turn the alarm off.

Fish Alarm

The Fish Alarm alerts you to the presence of fish, or other targets not attached to the bottom, in the water beneath your boat. The Fish Alarm has 3 different settings which correspond to the 3 different size fish targets shown on-screen.

To enable Fish Alarm, use the UP and DOWN arrow buttons to adjust the size return you want to be alerted to: large fish only, large and medium size fish, or all fish. Then press ENTER to enable the alarm.

Remember that it is impossible for sonar to determine if a signal return is a fish or some other type of object or suspended debris. Any object not connected to the bottom is normally a fish and is portrayed as a fish symbol. The strength of the reflected sonar signal from a target is a good indicator of the size of the target, and the fish symbol displayed represents the strength of the signal reflected from it.

Fish Alarm "On" Indicator

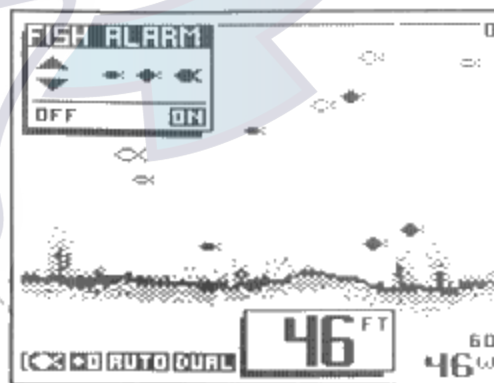

ID

ID is the automatic identification of target returns based on the strength of the returned signal and other factors. Three options are available: ID "On" displays targets as one of three different size fish symbols.

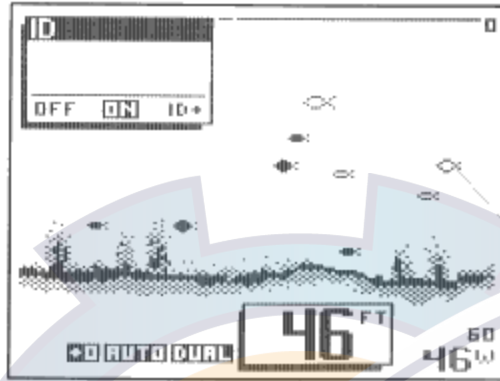

ID Symbols

Assuming the dual beam transducer is selected, these fish symbols can be either hollow, indicating that the target is detected in the wide beam only, or solid, indicating that the target is detected in the narrow beam, and is located directly under the boat.

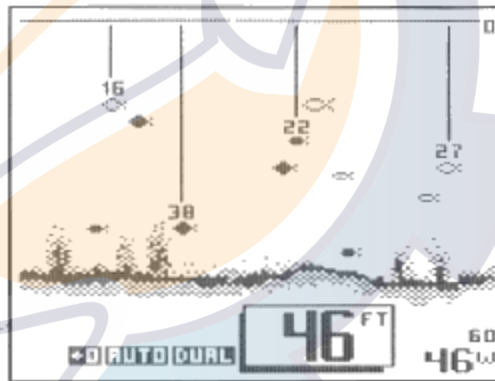

ID+ Depth Tags

"ID+", the default setting, provides more information about the location of the target by attaching depth "strings" showing the digital depth of the target. When there are numerous targets on-screen, not every target depth is shown, to avoid excessive clutter on-screen.

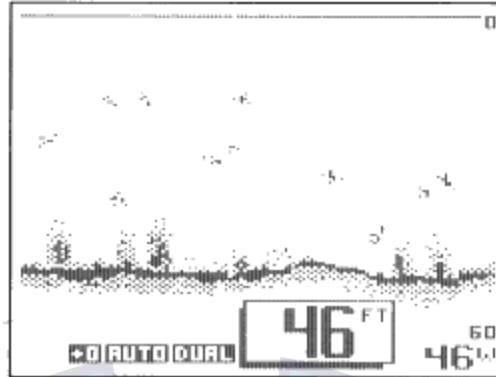

Raw Sonar Information

ID "Off" disables the units interpretation of targets, and displays the "raw" sonar information as it is received. Advanced users may prefer this type of presentation, so they can make their own interpretation from the information displayed.

TripLog

Triplog provides a time/distance calculation, based on input from the optional speed accessory. The timer is started when the unit is first powered, and distance information is collected to provide elapsed distance since power-up, and the average speed. To enable the Triplog display, press ENTER.

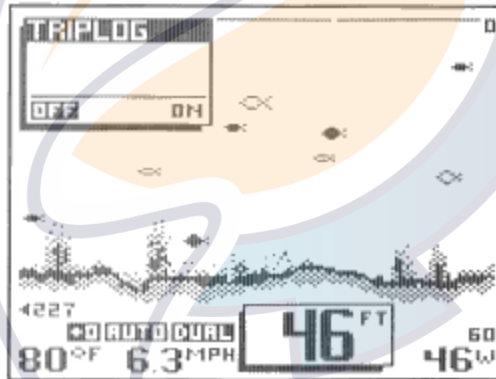

The Triplog can be reset at any time by pressing STOP. Press ENTER to return to the normal screen.

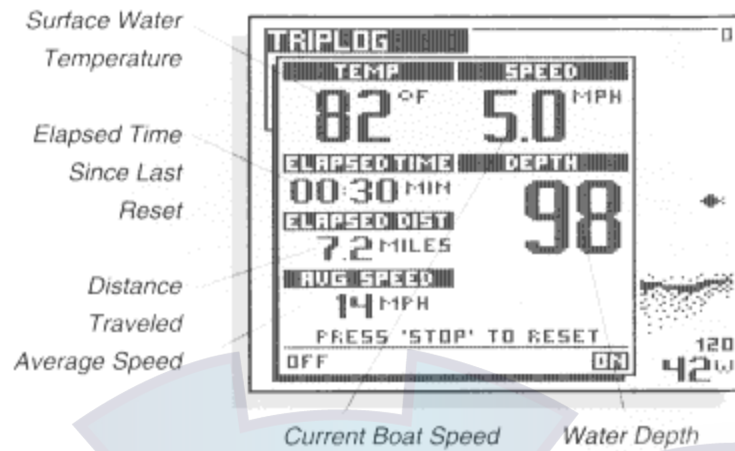

Note: The optional Speed & Temperature accessory must be connected for Triplog to work.

System Options

The System Options menu allows the adjustment of several additional features. These adjustments are usually made initially, and rarely thereafter. To make these adjustments, first enter the System Options full screen menu with the ENTER key. Then press MENU to choose the category for adjustment, the UP and DOWN arrow buttons to adjust the setting, and the ENTER key to return to the normal screen when you have finished.

Scroll Rate controls the rate of update of the display. There are five rate settings available. The default setting is rate 4 - you may speed up or slow down the update rate to match your personal preference. To present the most accurate representation of the terrain beneath your boat, the scroll rate of the display should be approximately synchronized to the speed of the boat. If your boat is stationary or moving slowly, select a slower scroll rate, and if you typically operate the boat at high speeds, use a faster scroll rate.

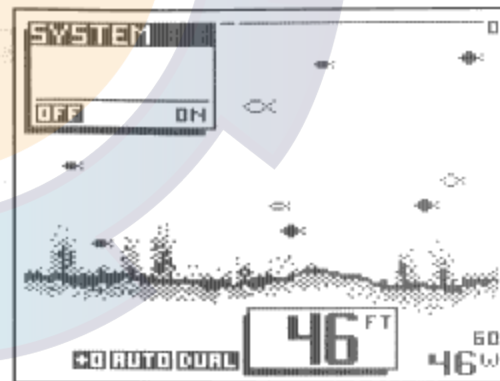

Contrast adjusts the display screen for easier viewing under given light conditions. There are 9 contrast settings available.

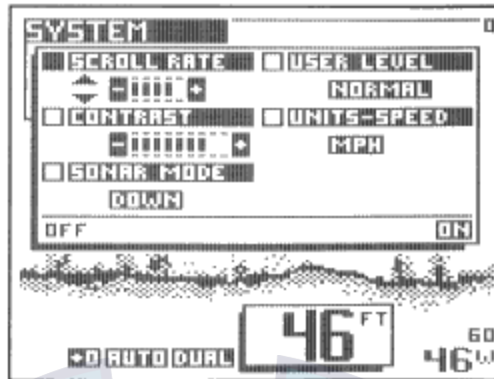

Sonar Mode is used to select the Side-Looking mode of operation if the Wide Side transducer is used. This setting changes the mode of operation of the Wide View to present information gathered from either side of the boat, and should not be used with the normal transducer. Refer to "Wide Side Operation" for more detailed information.

User Level is used to select Normal or Advanced operation. Advanced mode performs several functions which will benefit the experienced user. Icons are not shown and numerical data is smaller to allow more of the display to be used for the picture of the bottom. Several other changes in operation occur which are designed to increase the speed of adjustments, and maximize the graphic use of the display. Refer to "Advanced Operation" for more detailed information.

Units-Speed allows a selection between displaying speed in MPH or KTS. MPH displays your boat's speed in statute miles per hour and KTS displays your boat's speed in knots or nautical miles per hour.

Boat speed and water temperature features require the use of the optional temp/speed accessory, which must be purchased separately.

ADVANCED FEATURES

The Wide View contains the unique ability to be adaptable in operation to match the experience level of the user. Users inexperienced in the operation of the Wide View should use the factory "Normal" setting. As your experience increases, you will benefit from many of the changes that occur when "Advanced" operating mode is selected. The selection is made in the System Menu and affects the following:

The base screen layout is modified to make the maximum number of vertical pixels available for the active depth range. To accomplish this, symbols such as Sensitivity setting, and Fish Alarm indicators, are removed. The number of vertical pixels used in the range determine the units ability to separate targets which are close together, or close to the bottom. When the number of pixels in a given range is increased, the distance represented by each pixel is decreased.

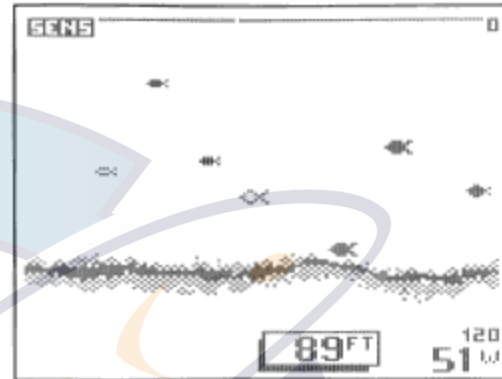

When a menu adjustment is made, the menu goes offscreen in approximately half the normal time. Menus are abbreviated and after an adjustment is made only a small indicator remains at the top of the screen so that you can make quick adjustments. This lets the experienced user make adjustments, then quickly return to full-screen viewing.

These changes are designed to make the maximum use of the available screen resolution, and speed up operations that restrict the view of the bottom.

Wide Side Operation

Wide Side is an accessory transducer that gives your Wide View the capability of collecting sonar information from either side of your boat. Side-looking sonar is extremely valuable for bank fishing, or looking for bait fish in open water.

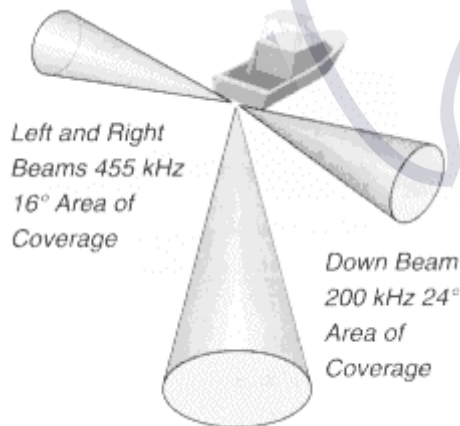

The Wide Side transducer contains 3 different elements which transmit signals to the left, right, and straight down from your boat. The downward beam is 200 kHz with a 24 degree area of coverage. This beam maintains a continuous digital depth readout from the bottom directly beneath your boat. The side beams are 455 kHz with a 16 degree area of coverage. These side-looking elements can be used independently, or together to locate targets near the surface of the water on either side of your boat.

The Wide Side transducer is available as a trolling motor mount, a transom mount, or a portable mount.

Wide Side can be connected directly to your Wide View unit in place of the dual beam transducer, or used in conjunction with a transducer switch so both transducers can be connected to the Wide View. See Installing the Wide View for additional information.

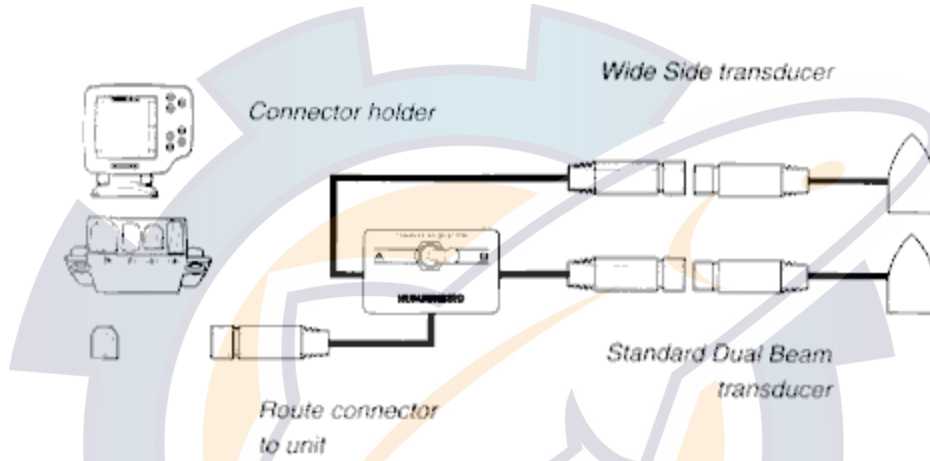
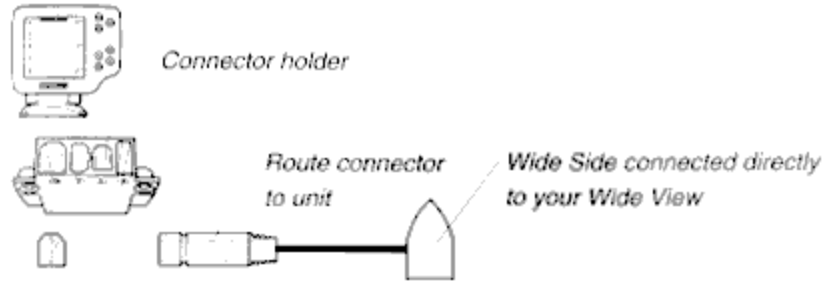

Also, several kits are available that include a Wide Side transducer with a switch or an additional mounting system. (See Section One, Available Accessories)



Sonar Mode Setting

When the Wide Side transducer is connected directly to your unit, or selected using a transducer switch, the unit setup must be changed to correspond with the type of transducer being used. This adjustment is made through the "System Options" menu. Use the MENU button to select the "System Options" menu and press ENTER. Press MENU until the "sonar mode" option is highlighted. Press UP or DOWN until "side" is displayed. Press ENTER when the selection is correct.

Your Wide View is now configured for Wide Side operation.



"Both" Beam Setting

When you exit the "System Options" menu, the view you will see on-screen is shown (bottom, left).

Viewing both left and right sides simultaneously gives you an excellent tool when searching for bait fish or following a creek bed, however greater display resolution can be achieved by viewing only one side.

Experiment with the Wide Side transducer while operating it in a familiar area and learn how to make maximum use of the information displayed. Remember, if you are using a trolling motor, the information displayed is controlled by the direction the trolling motor is pointing, not necessarily the direction the boat is travelling.

The information collected is controlled through the "Transducer" menu. The UP and DOWN arrow keys select "left", "right" or "both". Pressing ENTER will select the "down" mode and a traditional down view will be displayed. When "down" mode is selected, the single 24 degree down-looking element of the Wide Side transducer is used to collect this information. Unlike the dual beam transducer, the Wide Side transducer does not have "wide", "narrow" or "dual" beam options.

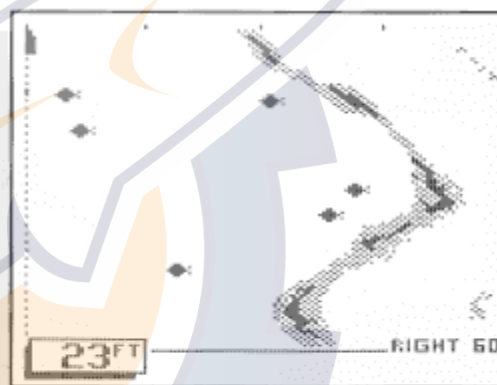

"Right" Beam Setting

The "Range" menu in Wide Side must be used to control the range manually, as the bottom is not always visible on-screen. Ranges of 15, 30, 60, and 120 feet are available.

"Zoom" has no function in Wide Side mode and the menu will not be present.

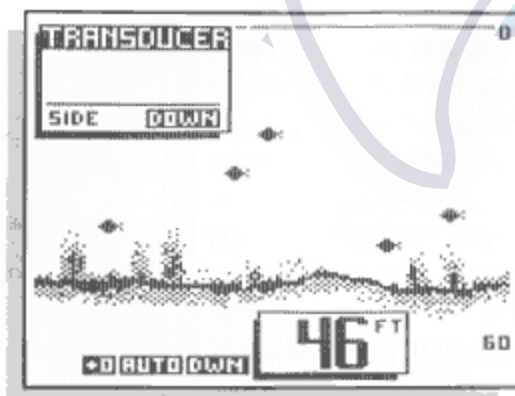

Wide Side "Down" Beam Setting

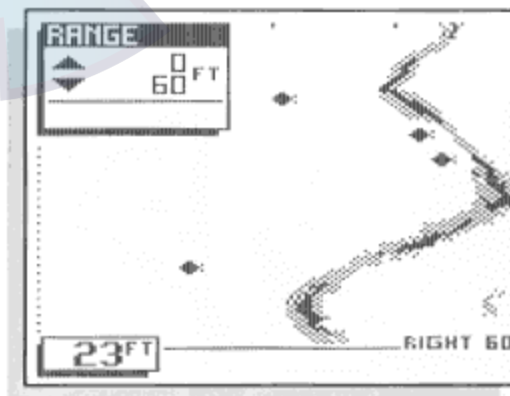

Range Menu

The "ID" menu is not present in Wide Side mode. Fish are displayed as three different size fish symbols, there are no hollow fish symbols to give directional information.

Most other menu functions work the same in Wide Side mode as with the standard dual beam transducer. "Bottom Alarm", "Fish Alarm", and "Sensitivity" have the same effect.

"Triplog" is available, if the optional speed and temperature accessory is connected.

To return to the normal "down" operation using the standard dual beam transducer, you must reconnect the dual beam transducer (by replacing the Wide Side connector) or use the switch to select the dual beam transducer. Next, configure the unit by selecting the "down" mode under the "System Options" menu.

Note: The "sonar mode" must always be configured to match the type of transducer being used.

